

Article number: 204490ZD801SR
 Description: E+G Ball catches
 GN 4490-ZD-80-1-SR

Measures

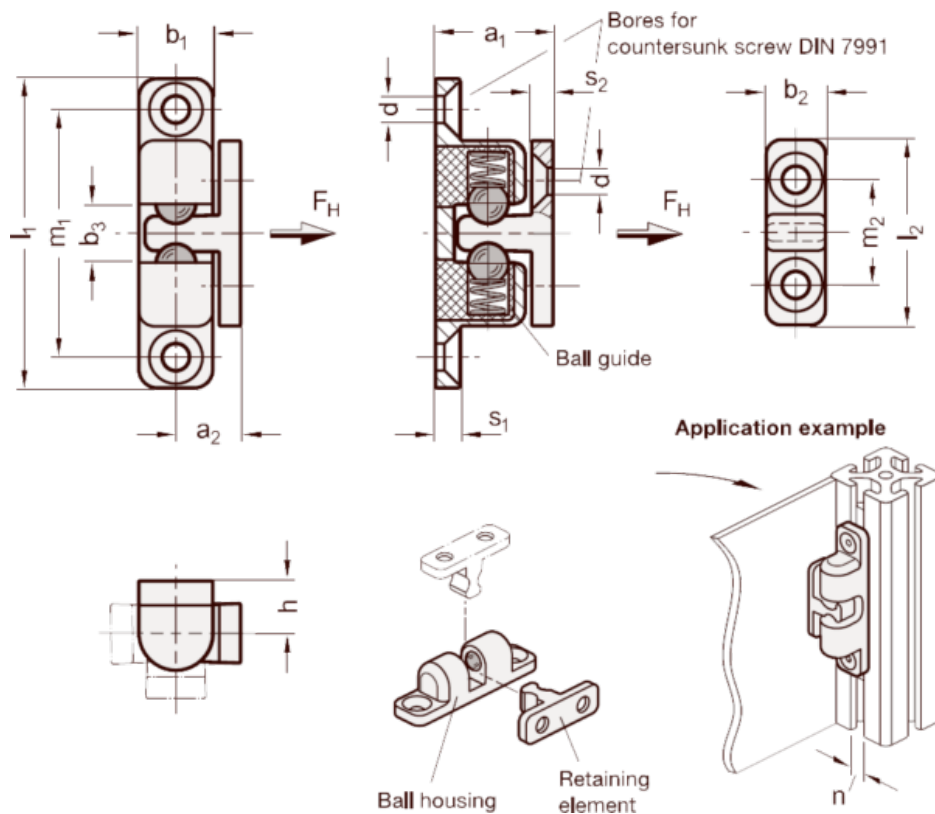

a1	= 27	Holding force FH in N	= 95
a2	= 14	l1	= 80
b1	= 16.5	l2	= 40
b2	= 13	m1	= 65
b3	= 11	m2	= 25
d	= M 5	s1	= 6
for nut width n	= ? 10	s2	= 4
h	= 13	Weight in (g)	= 88